

Biopharmaceutical in Pen Devices

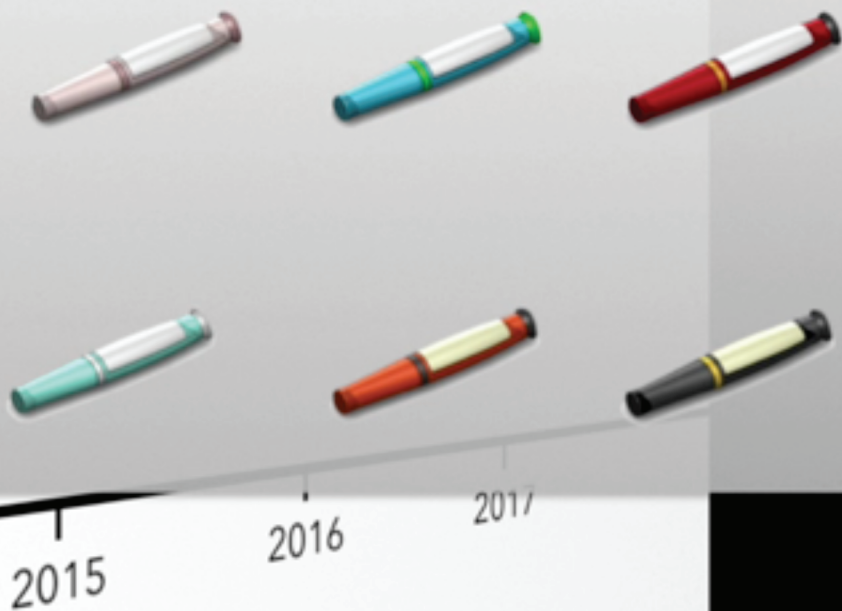

Production Process

Concept to Production

Concept

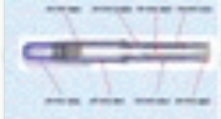

Design



Development



Validation



Production



ISO 14971/Design Control

ISO 13485/QSR

The Total Service

Drug Delivery System

Multi-Fixed Dose

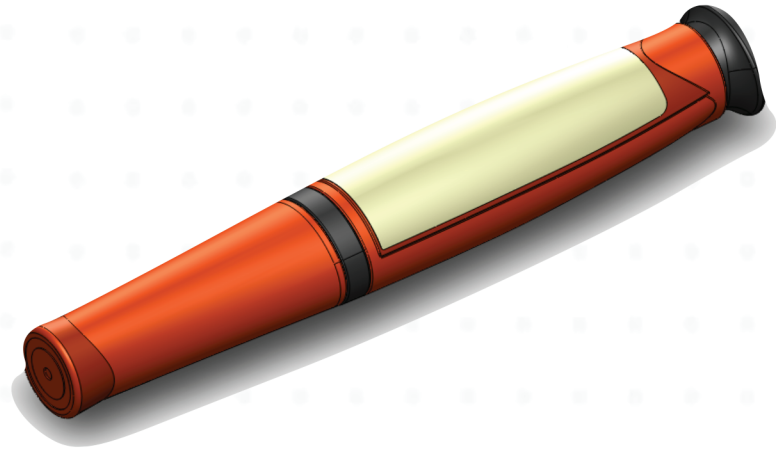
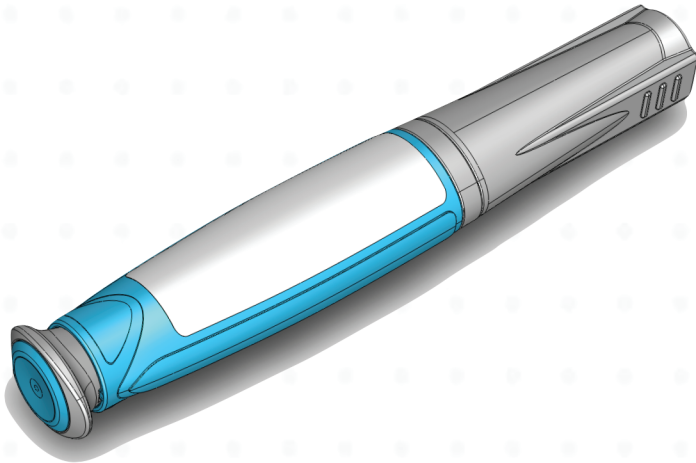

type	Primary Container	Usage	Dosage Type	Needle Attachment	Needle Insertion	Needle Removal	Intended use
injector	3ml cartridge	Multi-dose/ non-replaceable	Fixed dose	Manual	Manual	Manual	bio-similar

Drug Delivery System

Multi-Variable Dose

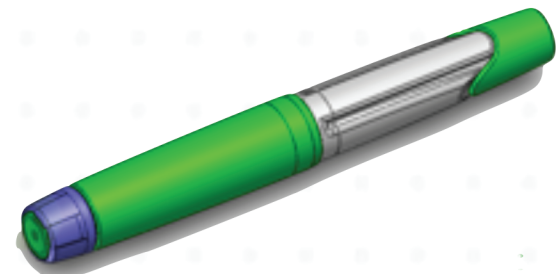
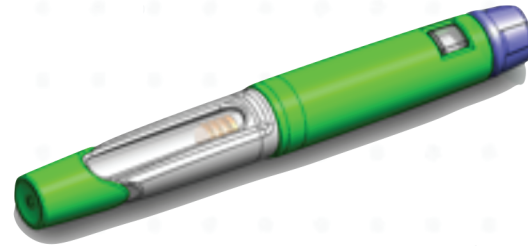
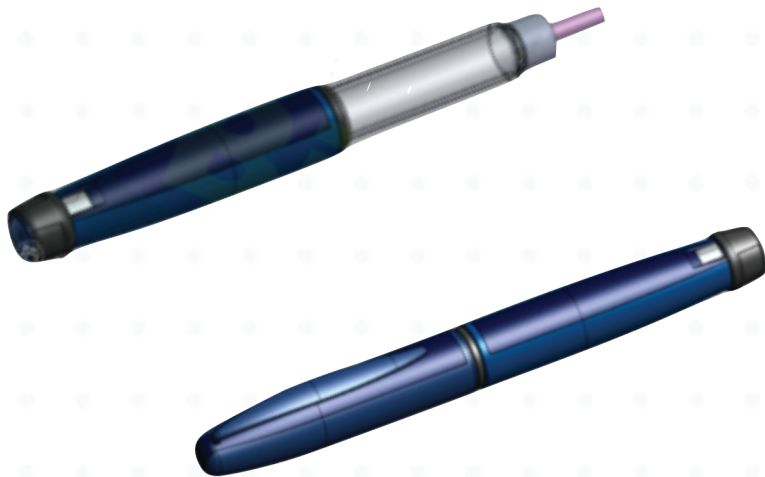

type	Primary Container	Usage	Dosage Type	Needle Attachment	Needle Insertion	Needle Removal	Intended use
injector	3ml cartridge	Multi-dose/ replaceable	Variable dose	Manual	Manual	Manual	Insulin pen

Drug Delivery System

Single-Fixed Dose



type	Primary Container	Usage	Dosage Type	Needle Attachment	Needle Insertion	Needle Removal	Intended use
injector	1ml pre-filled	single-dose/ non-replaceable	Fixed dose	Pre-attached	Manual	Manual	-

Drug Delivery System

Single-Fixed Dose



type	Primary Container	Usage	Dosage Type	Needle Attachment	Needle Insertion	Needle Removal	Intended use
injector	1ml cartridge	single-dose/ non-replaceable	Fixed dose	Pre-attached	Manual	Manual	vaccine

Drug Delivery System



Item No.	Capacity(ml)	Size(mm)			Accessary		Material	Remark
		H	W	L	Cap	Graduate		
AOC-60	60	92.6	φ38	-	AOC-L28	AOC-C37	HDPE	



Item No.	Capacity(ml)	Size(mm)			Accessary			Material	Remark
		H	W	L	Cap	Plug	Sleeve		
EDB-5	5	44.1	φ20.8	-	EDB-R001	EDB-R002	EDB-R003	HDPE+LDPE	

Quality Control

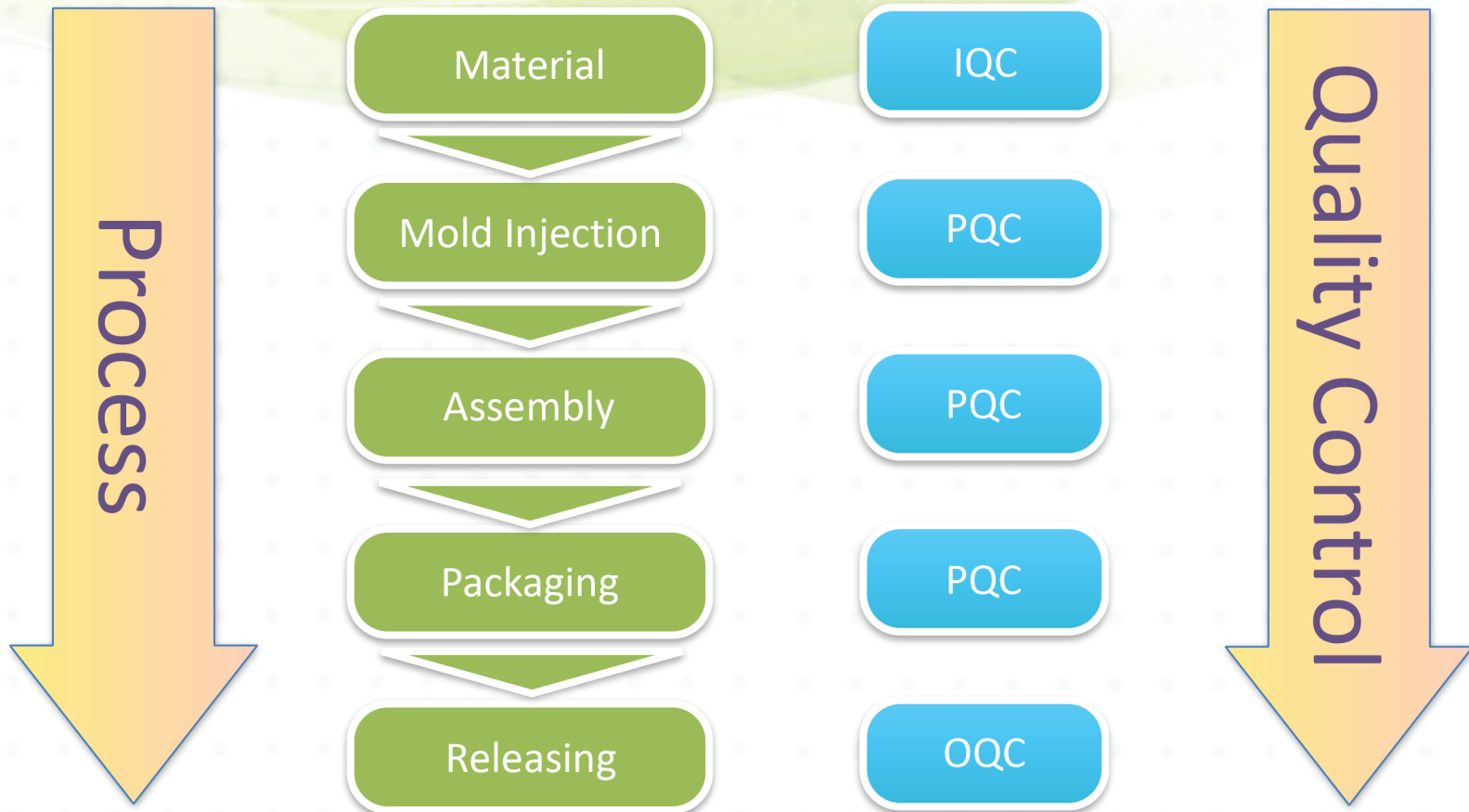

Good injection devices
can add values to your drugs
Thank you for your attention!
Questions?

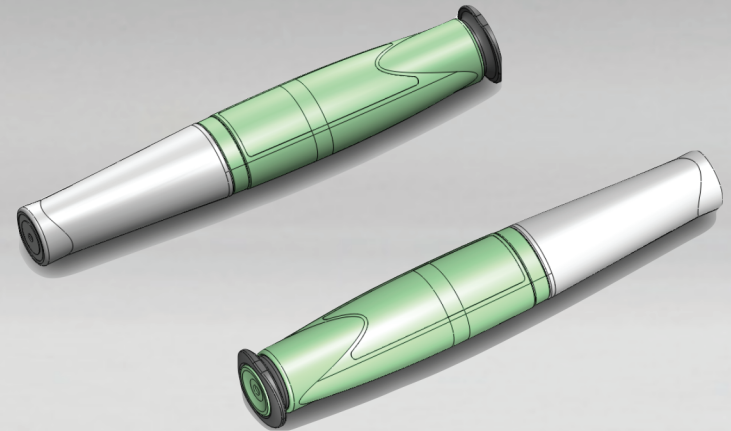

Medical Device Molding Solution

ODM and **OEM** for Medical Device



Chemie Trade Corporation

Suit-10/G, Azad Center, 55, Purana Paltan, Dhaka-1000, Bangladesh

Tel: 02-9578554, 9582016, Fax: 02-9582016

E-mail: ctc@agni.com/info@chemietradebd.com